

SHOWER GRATES specifications

RGS-100-76 100 x 100 x 76 mm

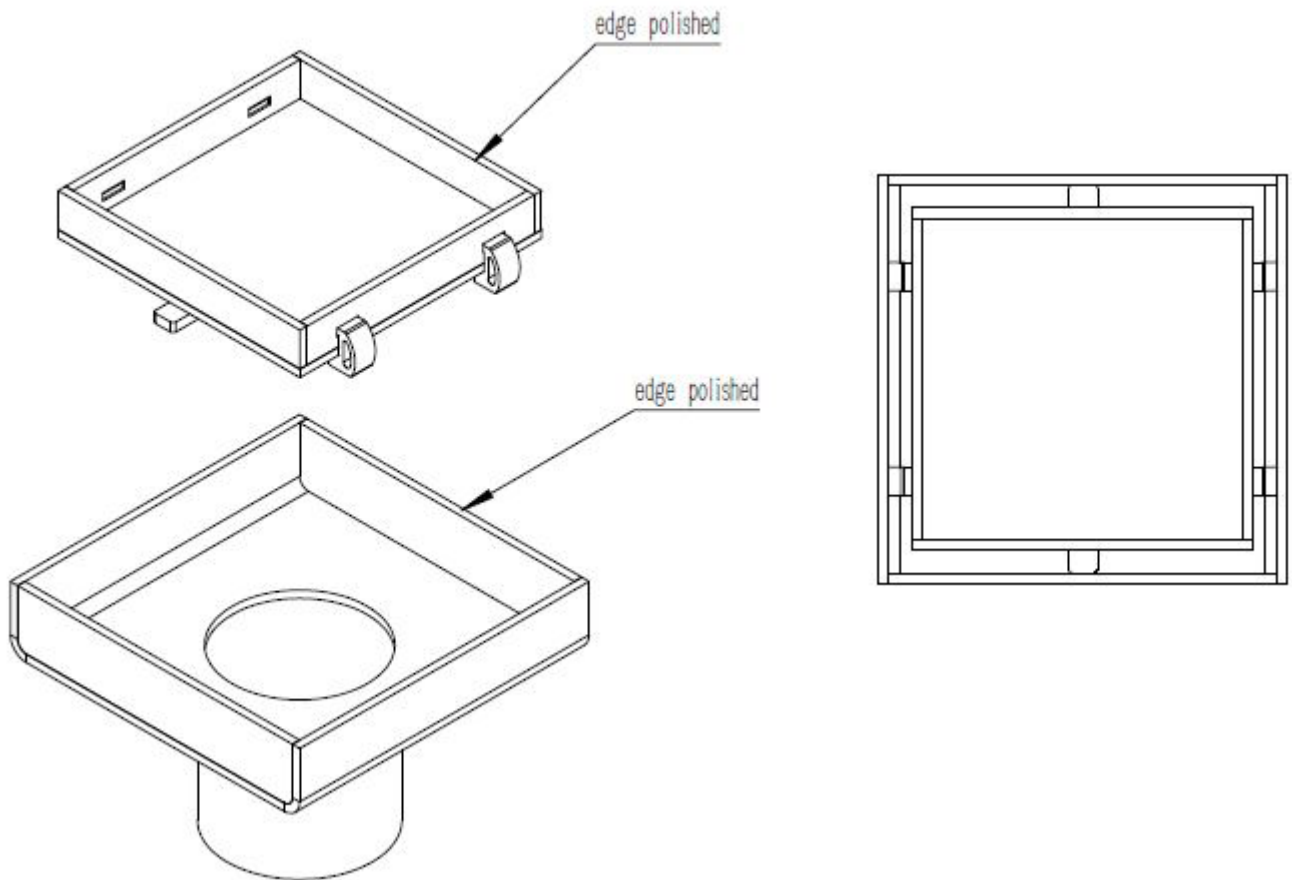

DESIGNED FOR TILE INSERT
MANUFACTURED FROM 304 GRADE
STAINLESS STEEL
COVERED BY A 7 YEAR WARRANTY
WASTE DIAMETER 76MM

